

tapered internal  
**plus**  
implant system

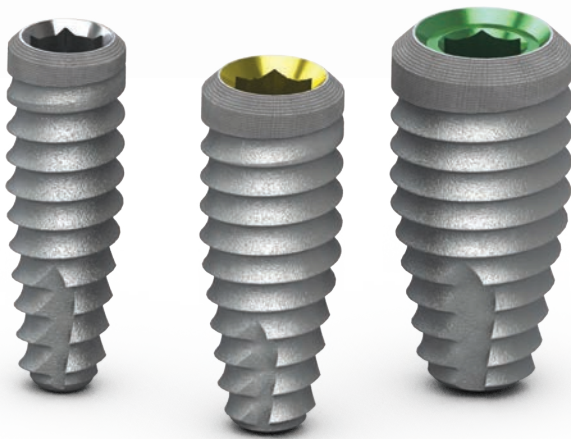

*designed for increased soft tissue volume*

**BIOHORIZONS**<sup>®</sup>  
SCIENCE • INNOVATION • SERVICE

99.2%  
average  
implant  
success  
rate<sup>1</sup>

BioHorizons is dedicated to developing evidence-based and scientifically proven products. From the launch of the External implant system (Maestro) in 1997, to the Tapered Internal Plus implant system in 2012, dental professionals as well as patients have confidence in our comprehensive portfolio of dental implants and biologics products.

Our commitment to science, innovation and service has made us one of the fastest growing companies in the dental industry. BioHorizons has helped restore smiles in 85 markets throughout Asia, North America, South America, Africa, Australia and Europe.

global  
leader for  
biologic  
based  
solutions



## SCIENCE

BioHorizons uses science and innovation to create unique products with proven surgical and esthetic results.

## INNOVATION

Our advanced implant technologies, biologic products and computer guided surgery software have made BioHorizons a leading dental implant company.

products  
sold  
in 85  
markets



## SERVICE

BioHorizons understands the importance of providing excellent service. Our global network of professional representatives and our highly trained customer care support team are well-equipped to meet the needs of patients and clinicians.

# Table of Contents

Tapered Plus Overview	2
Implants	3
Surgical Instruments	4-6
Ancillary Instruments	7-8
W&H Motors and Instruments	9-10
Healing Abutments and Cover Caps	11-12
Surgical Manual Introduction	13
Surgical Protocols	14
Implant Placement Level & Spacing	15
Surgical Kit & Drill Sequence	16
Drill Overview	17
Osteotomy Initialization	18
Osteotomy Modification	19
Final Bone Preparation & Drivers	20
Implant Transfer	21
Healing Protocols	22
Appendix	23
Icon Legend & References	24
Ordering & Warranty Information	25



# make the switch

The Tapered Plus implant system offers all the great benefits of BioHorizons highly successful Tapered Internal system PLUS it features a Laser-Lok treated beveled-collar for bone and soft tissue attachment and platform switching designed for increased soft tissue volume.

### platform switching

designed to increase soft tissue volume around the implant connection

### Laser-Lok® zone

creates a connective tissue seal and maintains crestal bone

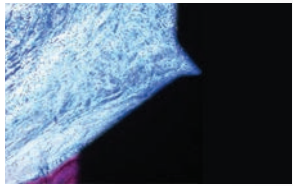

### optimized threadform

buttress thread engineered for superior stability over microthreaded implants

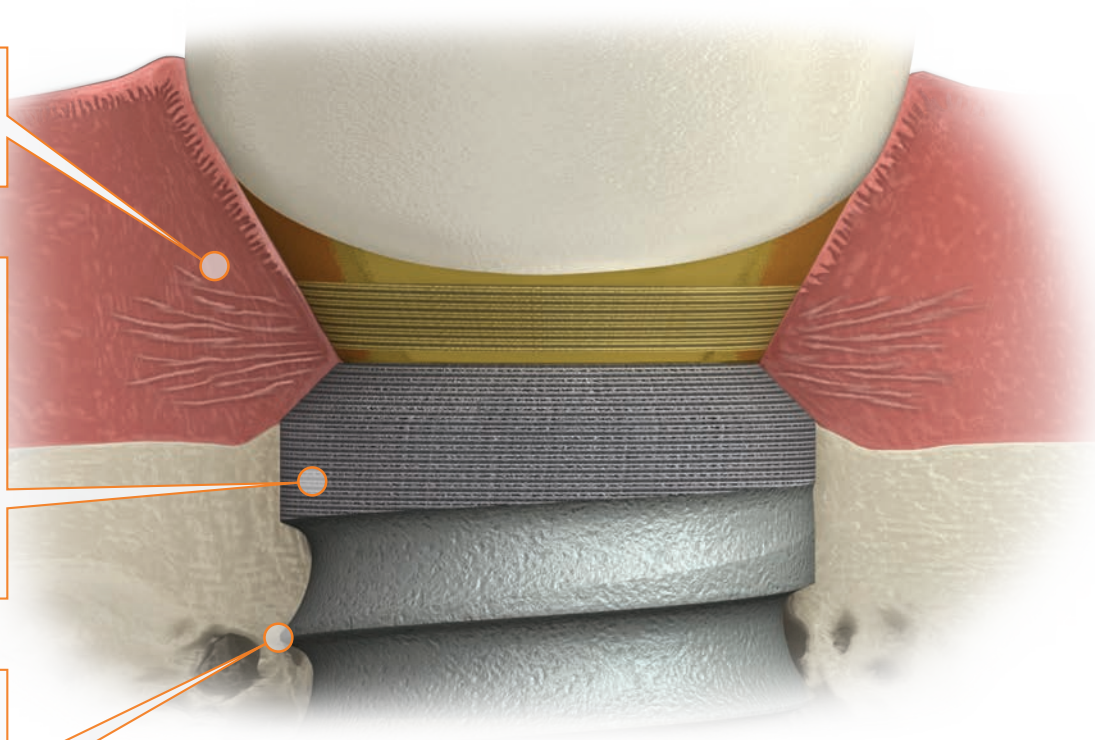

### restorative ease



conical internal hex connection is color-coded for quick identification and component matching









\* Clinical and histologic images are courtesy of Myron Nevins, DDS and Craig Misch, DDS.

## Dental Implants with Laser-Lok

### tapered 3.0

prosthetic connection	 3.0mm
body diameter	 3.0mm
platform switch	—
Laser-Lok zone	<b>2.1 mm</b>
7.5mm length	—
9.0mm length	—
10.5mm length	<b>TLX3010</b>
12.0mm length	<b>TLX3012</b>
15.0mm length	<b>TLX3015</b>

### tapered plus

prosthetic connection	 3.0mm	 3.5mm	 4.5mm
body diameter	 3.8mm	 4.6mm	 5.8mm
platform switch	<b>0.4mm</b>	<b>0.5mm</b>	<b>0.6mm</b>
Laser-Lok zone	<b>1.8mm</b>	<b>1.8mm</b>	<b>1.8mm</b>
7.5mm length	—	<b>TLXP4607</b>	<b>TLXP5807</b>
9.0mm length	<b>TLXP3809</b>	<b>TLXP4609</b>	<b>TLXP5809</b>
10.5mm length	<b>TLXP3810</b>	<b>TLXP4610</b>	<b>TLXP5810</b>
12.0mm length	<b>TLXP3812</b>	<b>TLXP4612</b>	<b>TLXP5812</b>
15.0mm length	<b>TLXP3815</b>	<b>TLXP4615</b>	<b>TLXP5815</b>

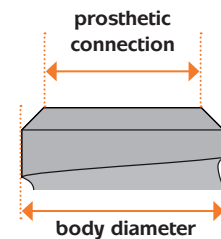
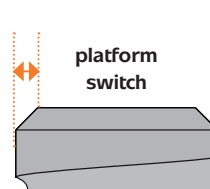
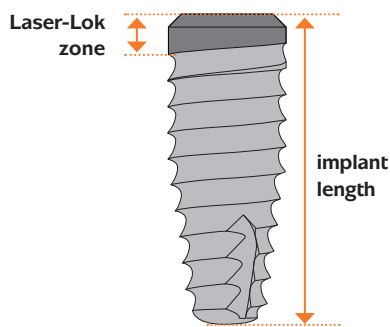

Mount-free for quick placement and maximum site visibility. Includes a surgical cover cap.  
Titanium Alloy (Ti-6AL-4V).

## Surgical Kit

### TSK3000

#### Surgical Kit (includes instruments)

Includes the instrumentation required to place: Tapered Plus, Tapered Internal, Tapered 3.0 and Laser-Lok 3.0.

### TSK2500

#### Surgical Tray & Lid (without instruments)

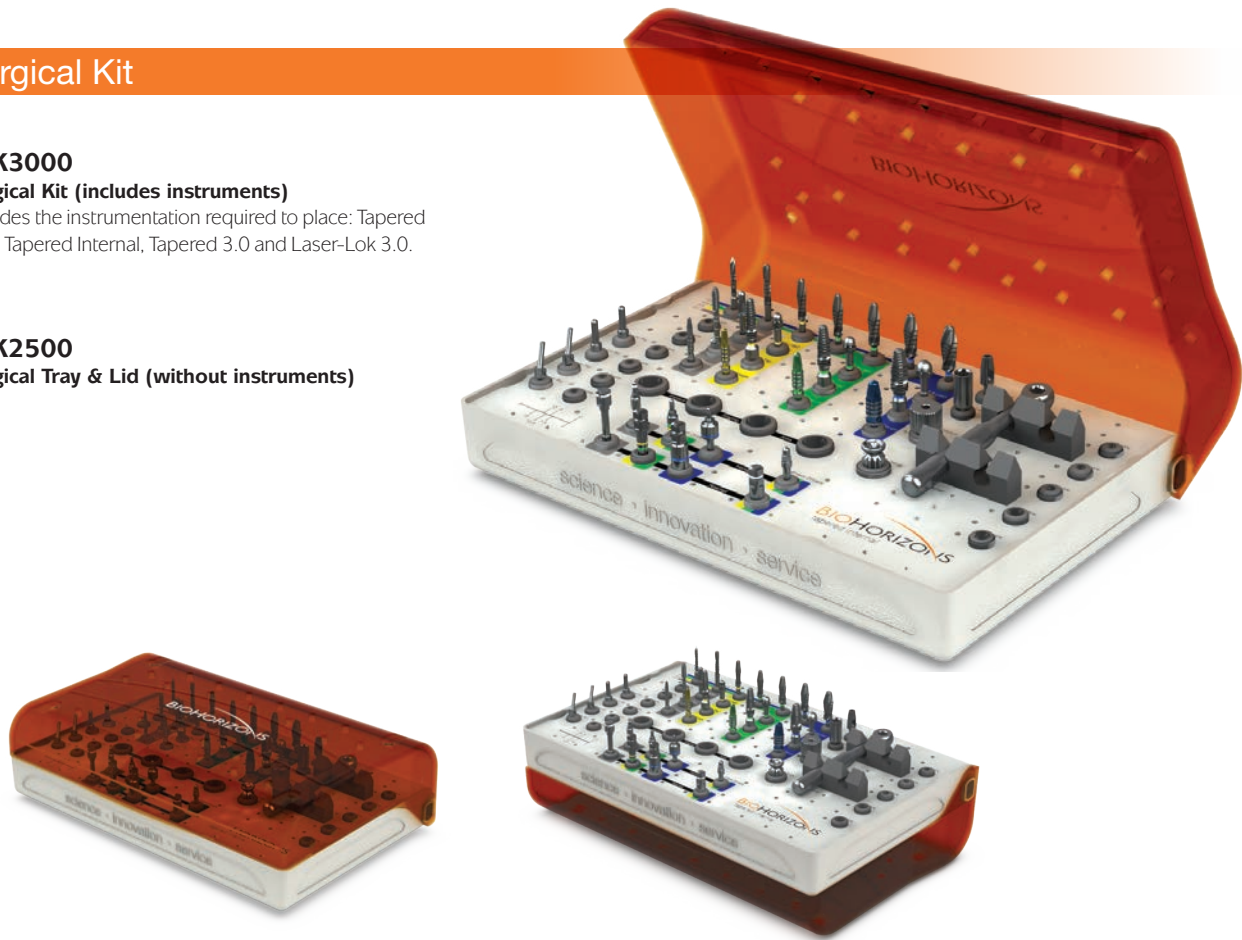

### Features:

- use to place Tapered Plus, Tapered Internal, Tapered 3.0 and Laser-Lok 3.0
- 40% smaller and 40% lighter than other kits
- versatile, removable, hinged lid
- easy to disassemble and assemble during cleaning
- implant staging area for implant vials during surgery
- empty spare slots for other instrumentation such as stop drills or extended shank drills

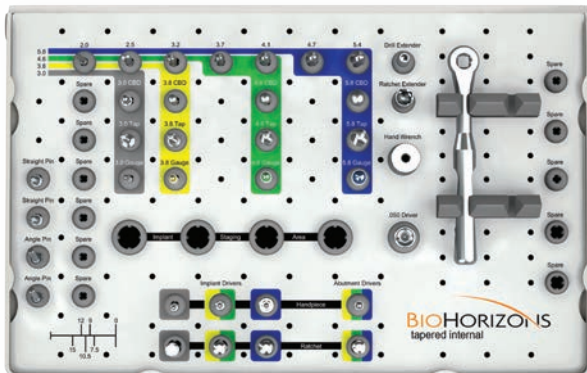

The surgical kit features an intuitive color-coded layout that guides the surgeon through the instrument sequence. The drilling section is color-coded by implant diameter. The implant driver section is color-coded by prosthetic connection.

# SURGICAL INSTRUMENTS

## Individual Components



**TSD2020**  
2.0mm Starter Drill (matte finish)

**TSD2025**  
2.5mm Depth Drill (matte finish)



**122-100**  
Drill Extender  
*(adds 16mm to length of drill)*



**144-100**  
Straight Parallel Pin

**144-200**  
20° Angled Parallel Pin



**TSD2032** 3.2mm Width Increasing Drill (matte finish)

**TSD2037** 3.7mm Width Increasing Drill (matte finish)

**TSD2041** 4.1mm Width Increasing Drill (matte finish)

**TSD2047** 4.7mm Width Increasing Drill (matte finish)

**TSD2054** 5.4mm Width Increasing Drill (matte finish)



**TP3CBD** 3.0mm Crestal Bone Drill

**TSC2038** 3.8mm Crestal Bone Drill

**TSC2046** 4.6mm Crestal Bone Drill

**TSC2058** 5.8mm Crestal Bone Drill



**122-900** 3.0mm Bone Tap

**TST2038** 3.8mm Bone Tap

**TST2046** 4.6mm Bone Tap

**TST2058** 5.8mm Bone Tap



**TDG2030** 3.0mm Depth Gauge

**TDG2038** 3.8mm Depth Gauge

**TDG2046** 4.6mm Depth Gauge

**TDG2058** 5.8mm Depth Gauge

### Important Note about drills

Drills, taps and depth gauges are color coded by implant body diameter:

- 3.0mm body - no color indicator
- 3.8mm body - yellow
- 4.6mm body - green
- 5.8mm body - blue

# SURGICAL INSTRUMENTS

## Individual Components

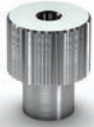

**300-400**  
Hand Wrench, 4mm Square



**300-206**  
4mm Square Drive Extender



**135-351**  
.050" (1.25mm) Hex Driver



**130-000**  
Ratchet



**TP3IDRR** 3.0mm Implant-level Driver, Regular, Handpiece

**TP3IDHR** 3.0mm Implant-level Driver, Regular, 4mm Square

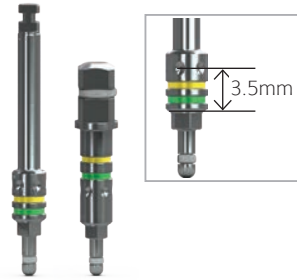

**SYGIDH** 3.5/4.5mm Implant-level Driver, Handpiece

**SYGIDR** 3.5/4.5mm Implant-level Driver, 4mm Square

### Important Note about drivers

Drivers are color coded by prosthetic connection:

- 3.0mm platform - no color indicator
- 3.5mm platform - yellow
- 4.5mm platform - green

*Note: Two abutment-level drivers and two 5.7mm implant level drivers are included in the TSK3000 kit for placing Tapered Internal implants, but are not used for placing Tapered Plus.*



## ANCILLARY INSTRUMENTS

### 2.5mm Tapered Depth Drills with stops



<b>TSD202507</b>	<b>2.5mm Tapered Depth Drill, 7.5mm Stop</b>
<b>TSD202509</b>	<b>2.5mm Tapered Depth Drill, 9mm Stop</b>
<b>TSD202510</b>	<b>2.5mm Tapered Depth Drill, 10.5mm Stop</b>
<b>TSD202512</b>	<b>2.5mm Tapered Depth Drill, 12mm Stop</b>
<b>TSD202515</b>	<b>2.5mm Tapered Depth Drill, 15mm Stop</b>

Stops are set to same length as each implant for crestal placement.  
Laser-etched line set 1 mm shorter for supracrestal placement.

### Extended Shank Drills



<b>TSD4020</b>	<b>2.0mm Ext. Shank Starter Drill</b>
<b>TSD4025</b>	<b>2.5mm Ext. Shank Depth Drill</b>
<b>TSD4032</b>	<b>3.2mm Ext. Shank Width Increasing Drill</b>
<b>TSD4037</b>	<b>3.7mm Ext. Shank Width Increasing Drill</b>
<b>TSD4041</b>	<b>4.1mm Ext. Shank Width Increasing Drill</b>
<b>TSD4047</b>	<b>4.7mm Ext. Shank Width Increasing Drill</b>
<b>TSD4054</b>	<b>5.4mm Ext. Shank Width Increasing Drill</b>

Extended Shank Drills are 8mm longer than our standard drills.

### Burs



<b>122-110</b>	<b>2.0mm Lindemann Bone Cutter</b>
----------------	------------------------------------

Side-cutting drill used to correct eccentric osteotomy preparations.

<b>122-106</b>	<b>#6 Round Bur</b>
----------------	---------------------

### Bone Profiling Burs



<b>TP3BP</b>	<b>3.0mm Bone Profiling Bur &amp; Guide</b>
<b>PYBP</b>	<b>3.5mm Bone Profiling Bur &amp; Guide</b>
<b>PGBP</b>	<b>4.5mm Bone Profiling Bur &amp; Guide</b>

Use at implant uncover to remove excess crestal bone for proper abutment seating.  
Screw the guide into the implant and align the profiling bur for precise bone removal.  
Match profiler & guide color to prosthetic connection.

# ANCILLARY INSTRUMENTS

## Tissue Punches



- 122-200** 3.0mm Tissue Punch (for a 3.3mm incision)
- PYTP** 3.5mm Tissue Punch (for a 3.9mm incision)
- PGTP** 4.5mm Tissue Punch (for a 4.7mm incision)
- PBTP** 5.7mm Tissue Punch (for a 6.1mm incision)

Use in flapless surgical procedures to remove a minimal amount of the soft tissue from the crest of the ridge prior to osteotomy preparation or during implant uncoverly.

## Handpiece Hex Drivers

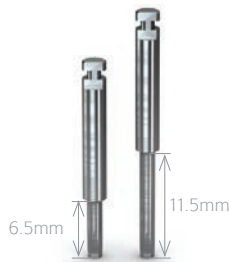

- 134-350** .050" (1.25mm) Handpiece Hex Driver
- 134-450** .050" (1.25mm) Handpiece Hex Driver, Long

For installation and removal of cover screws, healing abutments and abutment screws. The handpiece hex drivers are used with latch-type contra-angle handpieces. The Handpiece Hex Driver, Long (134-450) is 5mm longer than the standard version (134-350).

## Adjustable Torque Wrenches



**EL-C12374** Elos Adjustable Torque Wrench

Lightweight titanium design is easy to use as an adjustable torque wrench or a ratchet. Quickly disassembles for cleaning. No calibration required.



**ATW** ITL Precise Adjustable Torque Wrench

Place both implants and abutments with 9 distinct torque settings (15, 20, 25, 30, 35, 40, 45, 50 and 60 Ncm). A simple twist of the handle locks in precision-engineered torque values and guarantees accuracy and repeatability.

## Surgical Driver



**150-000** Surgical Driver

Use to drive implants into the osteotomy, particularly in the anterior region. Holds the 4mm Square implant-level drivers and the bone taps.

## Implant Spacer / Depth Probe



**144-300** Implant Spacer / Depth Probe

Use to provide intraoral measurements. Multi-functional tool for marking implant spacing on the ridge and probing osteotomy depth.

*\*instrument o-rings & c-rings wear out over time. If an instrument is no longer held securely by its associated driver, order a replacement ring through Customer Care.*

# W&H MOTORS AND ACCESSORIES

## W&H Motor Kits

Motor Kits include: console, handheld motor with cable, foot pedal, (3) disposable irrigation tubes, handpiece, bur testing gauge, service oil, and oil spray cap.



**WH-310L Elcomed SA-310 Professional Kit with LED**

Includes WS-75 LED handpiece (WH-10207530)

**WH-310 Elcomed SA-310 Professional Kit**

Includes WS-75 handpiece (WH-10207510)



**WH-915L Implantmed SI-915 Starter Kit with LED**

Includes WI-75 LED handpiece (WH-10207560)

**WH-915 Implantmed SI-915 Starter Kit**

Includes WI-75 handpiece (WH-10207550)

## W&H Ancillary Items



**WH-04363600 Disposable Irrigation Tubing, 2.2m (box of 6)**

(Implantmed and Elcomed SA-310)



**WH-04757100 Irrigation Spray Clip for External and Internal Irrigation (set of 3)**



**WH-10940011 MD-400 Service-Oil F1**



**WH-02139800 Bur Testing Gauge**

Use to verify latch-end instruments (drills, taps, drivers) meet dimensional specifications prior to use.



**WH-16934000 IA-400 Prosthodontic Screwdriver**

**WH-06338400 Irrigation Spike w/ Roller Clamp**

**WH-04013900 Pump Tube Complete (Implantmed and Elcomed SA-310)**

**WH-04014000 Spare Pump Tubes (Implantmed and Elcomed SA-310) (set of 3)**

**WH-00929300 Spray Tubes (box of 10)**

**WH-04019000 Tube Clamps (Implantmed) (set of 5)**

Contra-Angle Surgical Handpieces



<b>WH-10205601</b>	<b>WS-56 E Surgical Handpiece 1:1 Contra-Angle, Fully Dismantleable</b>
<b>WH-10207510</b>	<b>WS-75 E/KM Surgical Handpiece 20:1 Contra-Angle, Fully Dismantleable</b>
<b>WH-10207530</b>	<b>WS-75 E/KM LED G Surgical Handpiece 20:1 Contra-Angle, Fully Dismantleable</b>
<b>WH-10207550</b>	<b>WI-75 E/KM Surgical Handpiece 20:1 Contra-Angle, Mono Block</b>
<b>WH-10207560</b>	<b>WI-75 E/KM LED G Surgical Handpiece 20:1 Contra-Angle, Mono Block</b>
<b>WH-10209201</b>	<b>WS-92 E/3 Surgical Handpiece 1:2.7 Contra-Angle, Speed-Increasing, Fully Dismantleable</b>
<b>WH-12227901</b>	<b>EB-79 ENDO NiTi Handpiece 2:1 Contra-Angle</b>

Angled Surgical Handpieces



<b>WH-10100900</b>	<b>S-9 Surgical Handpiece 1:1 Angled</b>
<b>WH-10101000</b>	<b>S-10 Surgical Handpiece 1:1 Angled, Slim</b>
<b>WH-10101200</b>	<b>S-12 Surgical Handpiece 1:2 Angled, Speed-Increasing, Slim</b>

Straight Surgical Handpieces



<b>WH-00001100</b>	<b>S-11 Surgical Handpiece 1:1 Straight</b>
<b>WH-00001101</b>	<b>SL-11 Surgical Handpiece 1:1 Straight, Long</b>
<b>WH-00001120</b>	<b>SI-11 LED G Surgical Handpiece 1:1 Straight, Mono Block</b>
<b>WH-00001130</b>	<b>S-11 LED G Surgical Handpiece 1:1 Straight</b>



BioHorizons proudly distributes W&H implant motors, handpieces and accessories. Additional W&H products and re-order items are available. For more information, contact your BioHorizons representative or visit the online catalog ([www.biohorizons.com](http://www.biohorizons.com)).

# STANDARD HEALING ABUTMENTS & COVER CAPS

## Healing Abutments

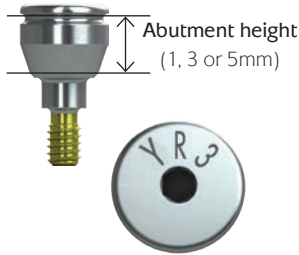

Hand-tighten with the .050" (1.25mm) Hex Driver. Titanium Alloy.

The 3.5 and 4.5mm healing abutments are laser marked for easy intraoral identification of the prosthetic platform, emergence and height; for example:

YR3 = Yellow (3.5mm) platform / Regular Emergence / 3mm High

3.0 healing abutments are not laser marked due to their small size.

prosthetic platform	abutment diameter	1 mm high	3mm high	5mm high
<b>Narrow Emergence</b>				
3.5mm Narrow Healing Abutment	3.8mm	<b>PYNHA1</b>	<b>PYNHA3</b>	<b>PYNHA5</b>
4.5mm Narrow Healing Abutment	4.7mm	<b>PGNHA1</b>	<b>PGNHA3</b>	<b>PGNHA5</b>
<b>Regular Emergence</b>				
3.0mm Regular Healing Abutment	3.5mm		<b>TP3HA3</b>	<b>TP3HA5</b>
3.5mm Regular Healing Abutment	4.5mm		<b>PYRHA3</b>	<b>PYRHA5</b>
4.5mm Regular Healing Abutment	5.5mm		<b>PGRHA3</b>	<b>PGRHA5</b>
<b>Wide Emergence</b>				
3.0mm Wide Healing Abutment	4.2mm		<b>TP3WHA3</b>	<b>TP3WHA5</b>
3.5mm Wide Healing Abutment	5.8mm		<b>PYWHA3</b>	<b>PYWHA5</b>
4.5mm Wide Healing Abutment	6.8mm		<b>PGWHA3</b>	<b>PGWHA5</b>

## Cover Caps



**TP3CC** 3.0mm Cover Cap

**PYCC** 3.5mm Cover Cap

**PGCC** 4.5mm Cover Cap

Use during submerged surgical healing. Hand-tighten with the .050" (1.25mm) Hex Driver. Titanium Alloy. *Included with implant but can also be ordered separately.*

# LASER-LOK HEALING ABUTMENTS

## Laser-Lok Healing Abutments

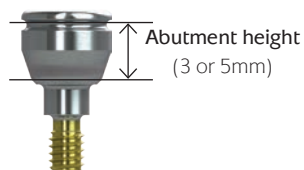

Use Laser-Lok healing abutments when a Laser-Lok abutment restoration is planned to inhibit epithelial downgrowth, establish a soft tissue seal and protect the bone. After removing a Laser-Lok healing abutment to make an impression, use a new Laser-Lok abutment (healing or final) to establish the soft tissue connection again.

prosthetic platform	abutment diameter	3mm high	5mm high
<b>Narrow Emergence</b>			
<b>3.5mm Narrow Healing Abutment, Laser-Lok</b>	3.8mm	<b>PYNHA3L</b>	<b>PYNHA5L</b>
<b>4.5mm Narrow Healing Abutment, Laser-Lok</b>	4.7mm	<b>PGNHA3L</b>	<b>PGNHA5L</b>
<b>Regular Emergence</b>			
<b>3.0mm Regular Healing Abutment, Laser-Lok</b>	3.5mm	<b>TP3HA3L</b>	<b>TP3HA5L</b>
<b>3.5mm Regular Healing Abutment, Laser-Lok</b>	4.5mm	<b>PYRHA3L</b>	<b>PYRHA5L</b>
<b>4.5mm Regular Healing Abutment, Laser-Lok</b>	5.5mm	<b>PGRHA3L</b>	<b>PGRHA5L</b>
<b>Wide Emergence</b>			
<b>3.0mm Wide Healing Abutment, Laser-Lok</b>	4.2mm	<b>TP3WHA3L</b>	<b>TP3WHA5L</b>
<b>3.5mm Wide Healing Abutment, Laser-Lok</b>	5.8mm	<b>PYWHA3L</b>	<b>PYWHA5L</b>
<b>4.5mm Wide Healing Abutment, Laser-Lok</b>	6.8mm	<b>PGWHA3L</b>	<b>PGWHA5L</b>

## Simple Solutions with Laser-Lok Healing Abutments

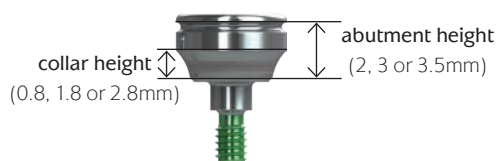

Use Laser-Lok Simple Solutions healing abutments when a Simple Solutions abutment restoration is planned to inhibit epithelial downgrowth, establish a soft tissue seal and protect the bone. A Simple Solutions restoration avoids having to remove and replace the abutment to take an impression because the snapcap closed tray impression transfer connects to the final abutment. See L01017 or L02007 for more information.

Simple Solutions emergence	abutment diameter	2mm high (0.8mm collar)	3mm high (1.8mm collar)	3.5mm high (2.8mm collar)
<b>3.5mm Simple Solutions Healing Abutment, Laser-Lok</b>	5.0mm	<b>PYHA08L</b>	<b>PYHA18L</b>	<b>PYHA28L</b>
<b>4.5mm Simple Solutions Healing Abutment, Laser-Lok</b>	6.0mm	<b>PGHA08L</b>	<b>PGHA18L</b>	<b>PGHA28L</b>

# INSTRUCTIONS FOR USE

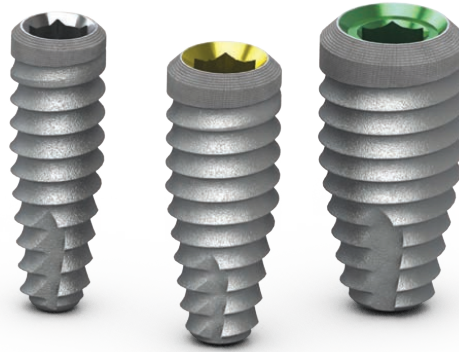

This surgical manual serves as a reference for using the Tapered Internal Plus and Tapered Internal 3.0 implants and surgical instruments. It is intended solely to provide instructions on the use of BioHorizons products. It is not intended to describe the methods or procedures for diagnosis, treatment planning, or placement of implants, nor does it replace clinical training or a clinician's best judgment regarding the needs of each patient. BioHorizons strongly recommends appropriate training as a prerequisite for the placement of implants and associated treatment.

The procedures illustrated and described within this manual reflect idealized patient presentations with adequate bone and soft tissue to accommodate implant placement. No attempt has been made to cover the wide range of actual patient conditions that may adversely affect surgical and prosthetic outcomes. **Clinician judgment as related to any specific case must always supersede any recommendations made in this or any BioHorizons literature.**

Before beginning any implant surgical procedure with BioHorizons implants:



- Read and understand the Instructions for Use that accompany the products.
- Clean and sterilize the surgical tray and instruments per Instructions for Use.
- Become thoroughly familiar with all instruments and their uses.
- Study surgical kit layout and iconography.
- Design a surgical treatment plan to satisfy the prosthetic requirements of the case.



Small diameter implants and angled abutments are intended for the anterior region of the mouth and are not intended for the posterior region of the mouth due to possible failure of the implant.

Note: the instructions in this surgical manual are consistent with those for Tapered Internal unless specifically stated.

## Indications

Tapered Internal Plus Implants are intended for use in the mandible or maxilla as an artificial root structure for single tooth replacement or for fixed bridgework and dental retention. The implants may be restored immediately:

- 1) with a temporary prosthesis that is not in functional occlusion or
- 2) when splinted together for multiple tooth replacement or when stabilized with an overdenture supported by multiple implants.

Tapered Internal 3.0 Implants may be used as an artificial root structure for single tooth replacement of mandibular central and lateral incisors and maxillary lateral incisors. The implants may be restored immediately:

- (1) with a temporary prosthesis that is not in functional occlusion,
- (2) when splinted together as an artificial root structure for multiple tooth replacement of mandibular incisors, or
- (3) for denture stabilization using multiple implants in the anterior mandible and maxilla.

The implants may be placed in immediate function when good primary stability has been achieved and with appropriate occlusal loading.

# SURGICAL PROTOCOLS

## Two-Stage Protocol

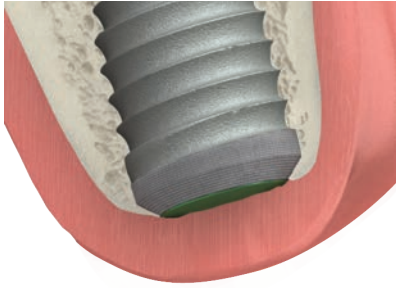

Implant with cover cap in a two-stage protocol.

In a two-stage surgery, the implant is placed below the soft tissue and protected from occlusal function and other forces during osseointegration. A low-profile cover cap is placed on the implant to protect it from the ingress of soft tissue.

Following osseointegration, a second procedure exposes the implant and a transmucosal healing abutment is placed to allow for soft tissue healing and development of a sulcus. Prosthetic restoration begins after soft tissue healing.

## Single-Stage Protocol



Implant with removable healing abutment in a single-stage protocol.

Single-stage surgery may be accomplished by placing a healing abutment at the time of implant surgery. This eliminates the need for a second procedure. Although the implant is not in occlusal function, some forces can be transmitted to it through the exposed transmucosal element.

Prosthetic restoration begins following osseointegration of the implant and soft tissue healing.

## Non-functional Immediate Restoration



Implant restored with a non-functional provisional prosthesis.

Single-stage surgery with non-functional immediate provisionalization provides the patient a non-functioning provisional prosthesis early in the treatment plan. An abutment is placed on the implant at or shortly after surgery, and a provisional restoration is secured using temporary cement. The provisional can help contour the soft tissue profile during healing.

## Immediate Function Restoration

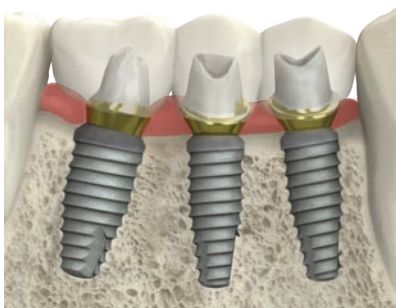

Implants with a splinted prosthesis in immediate function.

Single-stage surgery with immediate function is possible in good quality bone where multiple implants exhibiting excellent initial stability can be splinted together. Splinting implants together may offer a biomechanical advantage over individual, unsplinted prostheses.



# IMPLANT PLACEMENT LEVEL & SPACING

## Placement in Uneven Ridges

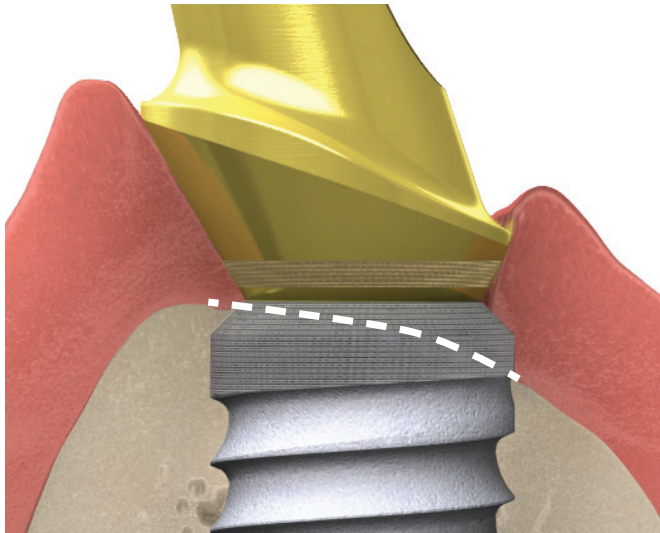

When placing the implant in an uneven ridge, prepare the osteotomy and place the implant so the bone/soft-tissue junction is within the Laser-Lok transition zone. This will allow both soft tissue and bone to attach to the Laser-Lok collar. If the ridge discrepancy is more than the Laser-Lok transition zone, leveling the ridge can be considered.

## Implant-to-Tooth Spacing

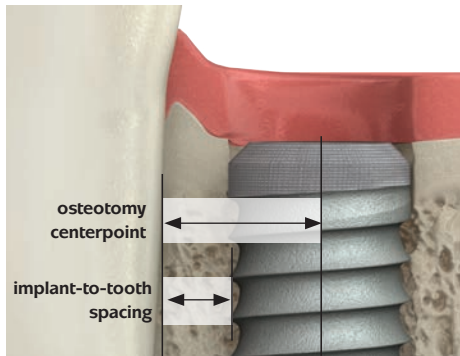

The osteotomy centerpoint required to maintain a specific implant-to-tooth spacing is calculated according to this formula:

$$\frac{1}{2} (\text{implant body diameter}) + \text{the desired spacing.}$$



*During implant placement, clinicians must apply their best judgment as to the appropriate spacing for individual patient conditions.*

## Implant-to-Implant Spacing

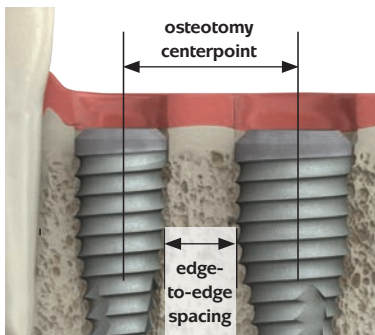

The osteotomy center-to-center measurement required to maintain a specific edge-to-edge spacing between two implants is calculated according to this formula:

$$\frac{1}{2} (\text{sum of 2 implant body diameters}) + \text{the desired spacing.}$$



*During implant placement, clinicians must apply their best judgment as to the appropriate spacing for individual patient conditions.*

# SURGICAL KIT & DRILL SEQUENCE

## Surgical Kit Instructions

The surgical kit uses an intuitive layout to guide the surgeon through the instrument sequence. The sequence begins in the upper left hand corner and works left-to-right and then down.

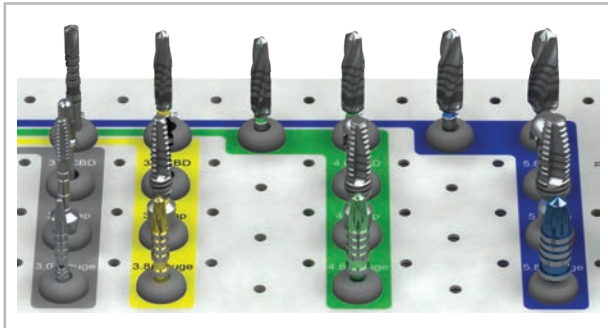

The drilling section is color-coded by implant body diameter (gray=3.0mm, yellow=3.8mm, green=4.6mm and blue=5.8mm).

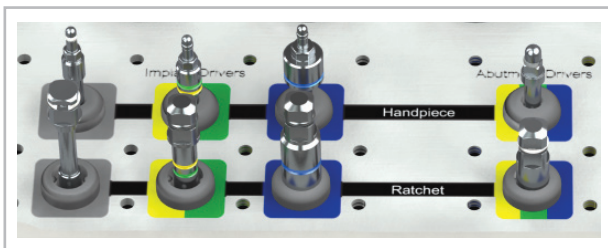

The implant driver section is color-coded by prosthetic platform (gray=3.0mm, yellow=3.5mm, green=4.5mm and blue=5.7mm).

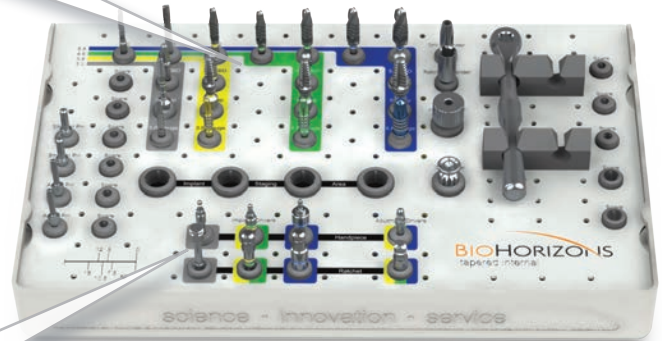

Prior to use, clean and sterilize the surgical tray and instruments according to the Instructions for Use included with the kit. Study the surgical kit layout, color-coding and iconography. Surgical assistants should be thoroughly familiar with all instruments and their uses prior to initiating the surgical procedure.

## Drill Sequence

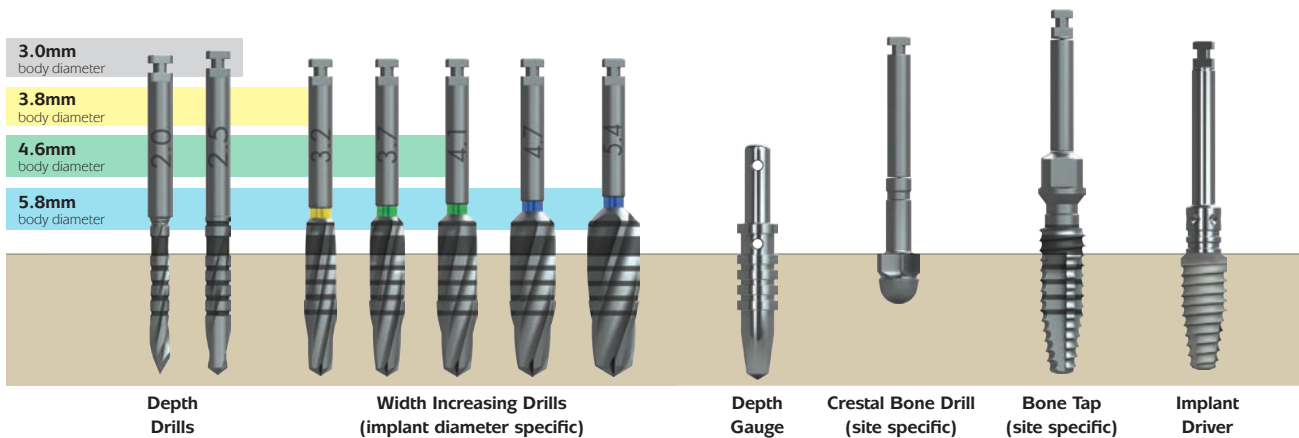

# DRILL OVERVIEW

## Drill Markings

All surgical drills included with this system are externally irrigated and designed to be used at drill speeds of 850-2500 rpm<sup>2</sup> with steady sterile irrigation. Reduced drill speed may be indicated in softer bone or as drill diameter increases.

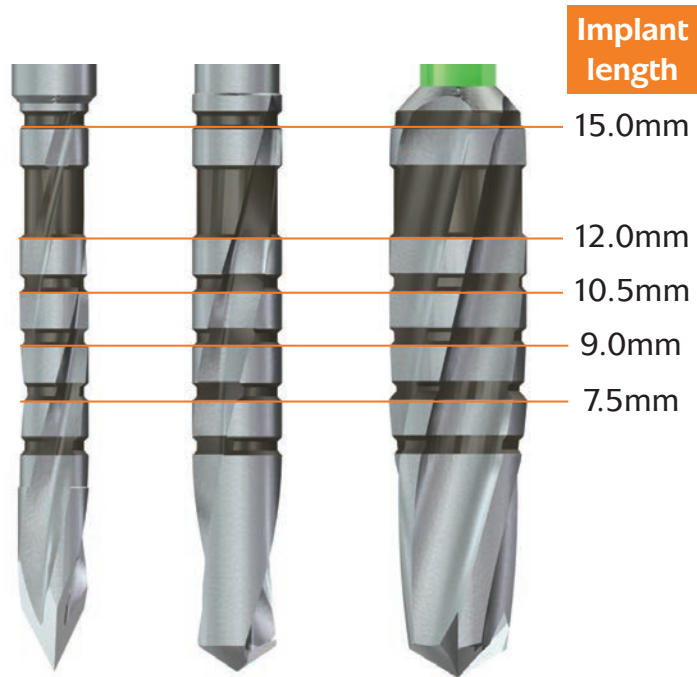

**Note: The depth marks are consistent throughout the starter drills, depth drills and width increasing drills**

## Important Considerations

- Peri-operative oral rinses with a 0.12% Chlorhexidine Digluconate solution have been shown to significantly lower the incidence of post-implantation infectious complications.<sup>3</sup> A pre-operative 30-second rinse is recommended, followed by twice daily rinses for two weeks following surgery.
- Drilling must be done under a constant stream of sterile irrigation. A pumping motion should be employed to prevent over-heating the bone. Surgical drills and taps should be replaced when they are worn, dull, corroded or in any way compromised. BioHorizons recommends replacing drills after 12 to 20 osteotomies.<sup>4</sup> A Drill-usage Tracking Chart is available at [biohorizons.com](http://biohorizons.com) to record this important information.
- There is a risk of injury to the mandibular nerve associated with surgical drilling in posterior mandibular regions. To minimize the risk of nerve injury, it is imperative that the clinician understands the drill depth markings as they relate to the implant length to produce the desired vertical placement of the implant.

# OSTEOTOMY INITIALIZATION

## 2.0mm Starter Drill



### 2.0mm Starter Drill

**Purpose:** Initiate osteotomy.

- Chisel-tip design eliminates “skating” on osseous crest
- Prepares site for paralleling pins
- Matte finish for increased visibility under operator lights

## 2.5mm Depth Drill



### 2.5mm Depth Drill

**Purpose:** Set osteotomy depth.

- Efficient cutting drill design collects bone for autografting
- Matte finish for increased visibility under operator lights
- Final drill for 3.0mm implant

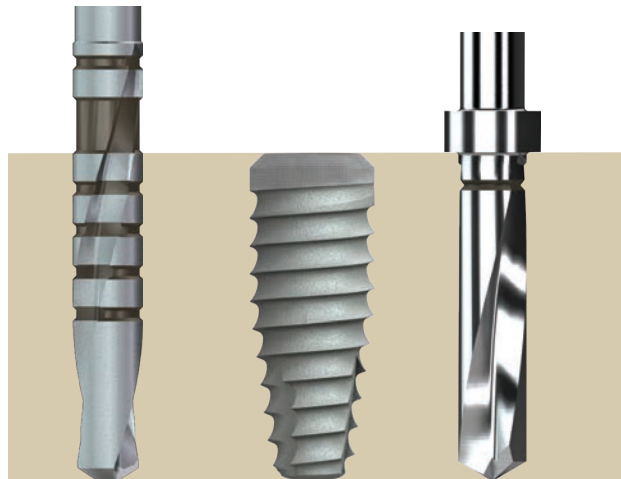

The 2.0mm and 2.5mm depth drills are designed to increase and/or set the depth of the osteotomy.

## 2.5mm Depth Drills with Stops



**Purpose:** Set osteotomy depth when access or visibility is poor.

- Fixed circular ring acts as a definitive drill stop
- One drill length for each implant length
- 1 mm laser-etched line guides supracrestal implant placement
- BioHorizons Surgical Kit includes spare slots for depth drills with stops or extended shank drills
- Optional final drill for 3.0mm implant

# OSTEOTOMY MODIFICATION

## Paralleling Pins



**Purpose:** Evaluate osteotomy position and angle.

- Provided straight or with a 20° angle
- Use after 2.0mm Starter Drill and 2.5mm Depth Drill
- 9mm shank for radiographic evaluation of proximity to adjacent anatomy
- Hub diameter is 4.0mm

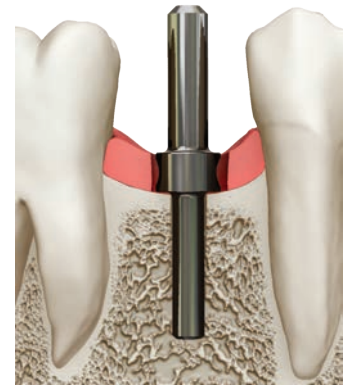

## Width Increasing Drills



**Purpose:** Incrementally widen the osteotomy to reduce heat generation.

- Depth-marked for reference
- Efficient cutting drill design collects bone for autografting
- The drill tip has limited end cutting. However, the osteotomy depth can be increased with these drills as needed
- Matte finish for increased visibility under operator lights
- Color-coded by implant body diameter (gray=3.0mm, yellow=3.8mm, green=4.6mm and blue=5.8mm)

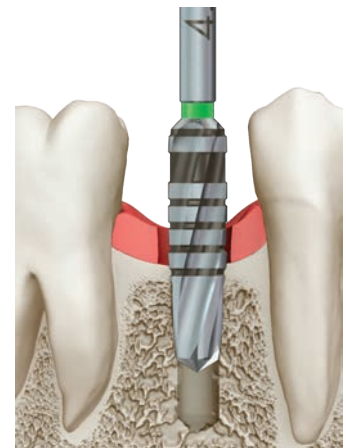

## Depth Gauges



**Purpose:** Verify osteotomy depth.

- Depth marks for reference
- Use following the final width increasing drill for each implant
- Place the depth gauge into the osteotomy site, adjust osteotomy depth as necessary
- Can also be used after 2mm drill by inverting
- Color-coded by implant body diameter (gray=3.0mm, yellow=3.8mm, green=4.6mm and blue=5.8mm)

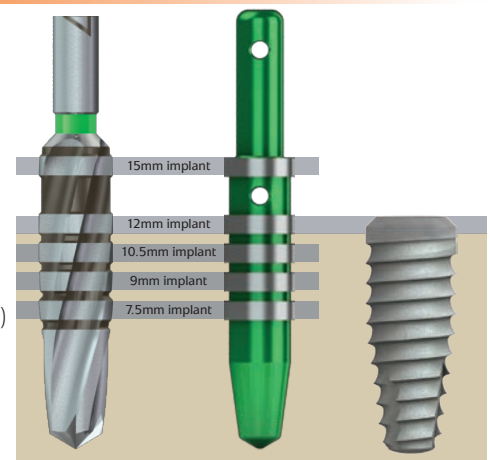

Width increasing drill

Depth gauge

12mm implant with Laser-Lok

# FINAL BONE PREPARATION & DRIVERS

## Crestal Bone Drills



**Purpose:** Remove cortical bone at ridge crest for pressure-free seating of the implant collar.

- Use when dense cortical bone is present at crest
- Rounded non-end cutting hub centers drill in osteotomy
- Use following the final width increasing drill for each implant
- Drill to the first line for Tapered Plus. Drill to the second line for Tapered Internal

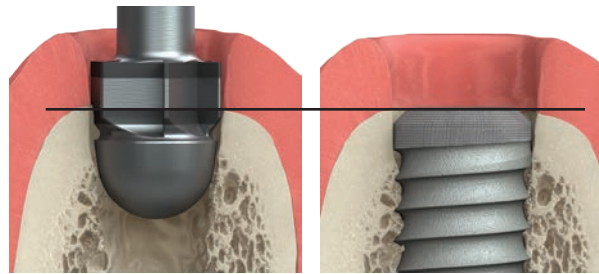

Seat drill to the first line.

Implant level with osseous crest.

## Bone Taps



**Purpose:** Prepare dense cortical bone for implant threads.

- Site specific
- 30 rpm or less<sup>5</sup>
- Final instrument prior to implant placement
- Can be driven with a handpiece, ratchet or hand wrench

Place into the osteotomy, apply firm apical pressure and rotate slowly in a clockwise direction. When the threads engage, allow the tap to feed without excessive pressure. To remove, rotate the bone tap in a counter-clockwise direction, allowing it to back out of the osteotomy. **Do not pull on the bone tap to remove it from the site.**

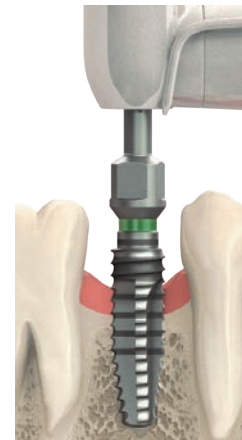

## Implant Drivers



**Purpose:** Engage the implant's internal hex to drive mount-free implants into the osteotomy at 30 rpm or less.<sup>5</sup>

- Drivers are color coded by prosthetic connection:
- gray = 3.0mm platform
  - yellow/green = 3.5/4.5mm platform

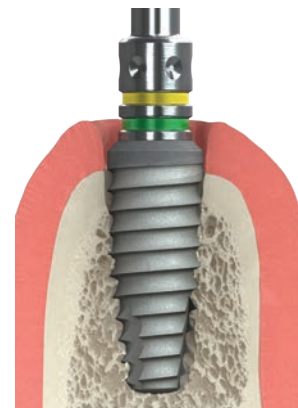

# IMPLANT TRANSFER

## Mount-free Transfer

Vial caps are color coded by body diameter (3.0=white, 3.8mm=yellow, 4.6mm=green, 5.8mm=blue).  
Cover caps and implant drivers are color coded by prosthetic platform (3.0mm=gray, 3.5mm=yellow, 4.5mm=green).

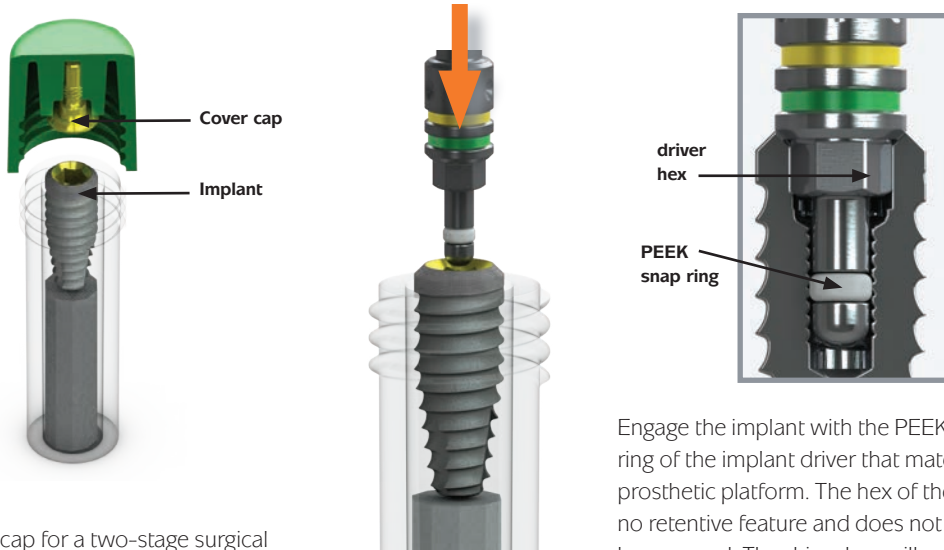

The cover cap for a two-stage surgical protocol is mounted in the vial cap.

Engage the implant with the PEEK snap ring of the implant driver that matches the prosthetic platform. The hex of the driver has no retentive feature and does not need to be engaged. The driver hex will automatically engage in the osteotomy when the driver is slowly rotated under apical pressure.

## Implant Placement

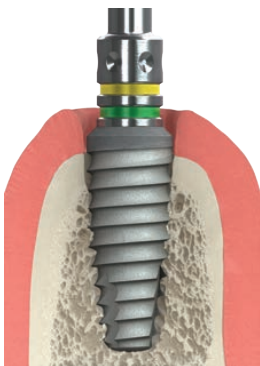

Place the apex of the implant into the osteotomy and begin rotating slowly. The driver hex will engage when the driver is slowly rotated under apical pressure. If too much resistance is felt during insertion, remove the implant and revise the osteotomy with the appropriate crestal bone drill or bone tap as deemed necessary to reduce insertion torque.

## Internal Hex Orientation

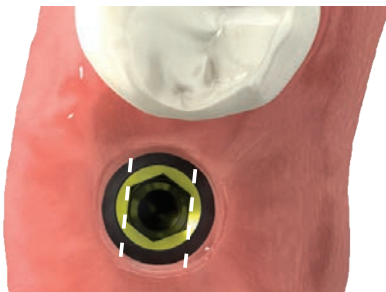

When seating the implant, use the corresponding dimples on the driver to orient one internal hex flat perpendicular to the implant angulation plane. Doing so verifies that an angled abutment will correct the angulation.

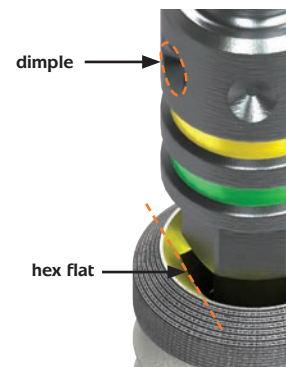

# HEALING PROTOCOLS

## Cover Caps for two-stage protocol



**Purpose:** Protects prosthetic platform in two-stage (submerged) surgical protocols.

- Irrigate implant to remove blood and other debris
- Use an antibacterial paste to decrease the risk of bacterial growth
- Thread clockwise into implant body
- Hand-tighten (10-15 Ncm) utilizing .050" (1.25mm) Hex Driver
- Color-coded by prosthetic platform

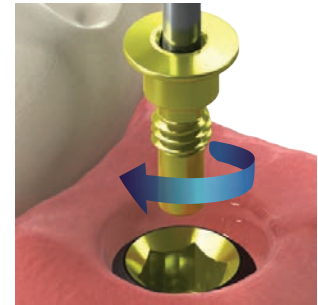

## Healing Abutments for single-stage protocol



**Purpose:** Transmucosal element for developing soft tissue emergence with narrow, regular, wide emergence or Simple Solutions prosthetic components.

- Hand-tighten (10-15 Ncm) utilizing .050" (1.25mm) Hex Driver
- Color-coded by prosthetic platform
- The 3.5 and 4.5mm healing abutments are laser marked for easy intraoral identification; for example:  
YR3 = Yellow (3.5mm) platform / Regular Emergence / 3mm High
- If a Laser-Lok temporary or final restoration is planned, a Laser-Lok healing abutment is required



## Immediate Provisional Restorative Options



### Temporary Abutments

**Purpose:** Titanium and PEEK temporaries are easily modified for fabrication of cement or screw-retained provisional restorations. A long direct coping screw (purchased separately) may be used to maintain the screw access hole during the fabrication of a screw-retained provisional prosthesis.



### Simple Solutions with Laser-Lok

**Purpose:** When a Simple Solutions restoration is planned, the tooth-colored healing cap that comes packaged with the abutment may be used as a coping for an immediate provisional restoration. See L01017 or L02007 for more information.



## Post-operative Instructions

A period of unloaded healing time is often recommended to allow for integration between the bone and implant surface. This is dependent on individual patient healing rates and bone quality of the implant site. Each case must be independently evaluated.

The patient should be instructed to follow a post-surgical regimen including cold packs for 24 hours post-implantation. The patient's diet should consist of soft foods and possibly dietary supplements. Pharmacological therapy should be considered as the patient's condition dictates.

If a removable prosthesis is used during the initial healing phase, a soft liner material should be used to prevent pressure on the surgical site. Relieve the prosthesis over the implant site prior to the soft liner application. Periodically check the patient's soft tissue and bone healing using clinical and radiographic evaluations.

Ongoing hygiene for the implant patient is vital. Hygiene recall appointments at three month intervals are suggested. Instruments designed for implant abutment scaling, such as Implacare® instruments from Hu-Friedy® should be utilized. The stainless steel handles may be fitted with assorted tip designs for hygiene on natural teeth. The Implacare® scalers contain no glass or graphite fillers that can scratch titanium implant abutments.

## Bone Profilers



**Purpose:** In cases where excess crestal bone has been created, use a bone profiler at implant uncover to contour the bone. This will provide the necessary clearance for proper abutment seating.

- 850-2,500 rpm drill speed with steady sterile irrigation<sup>2</sup>
- Profiler guide protects implant platform
- Color-coded by prosthetic platform (gray=3.0mm, yellow=3.5mm, green=4.5mm)

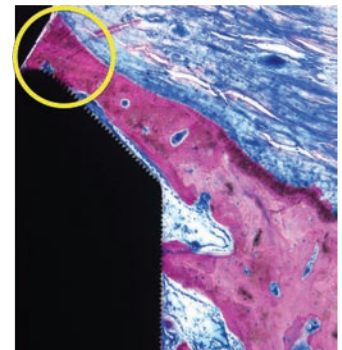

*Image showing excess bone growth at 3 months (Myron Nevins, DDS.)*

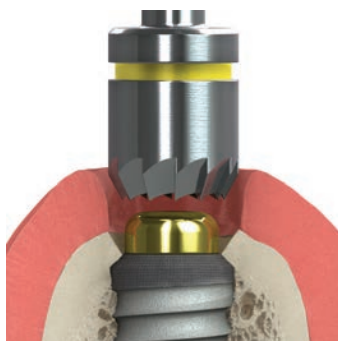

**Do not use the profiler without the guide in place.**

Using an .050" hex driver, remove the surgical cover cap from the implant and place the profiler guide that matches the color of the prosthetic platform. Use the profiler with copious amounts of sterile irrigation. Once the excess bone and soft tissue are removed, unscrew the guide and seat the appropriate prosthetic component.

# ICON LEGEND & REFERENCES

## Symbol Descriptions for Product Labeling

The diagram shows a product label for a BioHorizons implant. Callouts on the left explain the following elements:

- [REF]** Reference/article number
- [LOT]** Lot/batch number
- Hourglass icon** Use before expiration date (YYYY-MM)
- Wave icon** Manufacture date (YYYY-MM)
- [STERILE]R** Sterile by gamma irradiation
- [NON-STERILE]** Non-sterile
- Rx Only** Caution: Federal (USA) law restricts these devices to the sale, distribution and use by, or on the order of, a dentist or physician.
- Artwork label number**

Callouts on the right explain the following elements:

- Single use only icon** Single use only
- Warning triangle icon** Refer to Instructions for Use
- CE 0473** BioHorizons products carry the CE mark and fulfill the requirements of the Medical Devices Directive 93/42/EEC
- EU Authorized Representative** Quality First International, Suites 317/318 Burford Business Centre, 11 Burford Road, Stratford, London E15 2ST United Kingdom. Tel. +44-208-221-2361, Telefax +44-208-221-1912

The label itself contains the following text and symbols:

**4.6 x 12**  
Tapered Internal Plus

**BIOHORIZONS®**  
Birmingham, AL 35244 USA

**[REF]** TLXP4612

**[LOT]** YYXXXXX

Laser-Lok  
4.6 x 12mm, 3.5 Platform

**[LOT]** YYXXXXX

YYYY-MM expires

YYYY-MM manufacture date

**[STERILE]R** gamma irradiated

**Rx Only**  
LTLXP4612 Rev A

**CE 0473**

do not re-use

see instructions for use

BioHorizons Tapered Plus  
**[REF]** TLXP4612 **[LOT]** YYXXXXX  
4.6 x 12mm, 3.5 Platform

BioHorizons Tapered Plus  
**[REF]** TLXP4612 **[LOT]** YYXXXXX  
4.6 x 12mm, 3.5 Platform

body diameter	prosthetic platform
<b>3.0mm</b> (gray box label & white vial cap)	<b>3.0mm</b> (gray internal hex & cover cap)
<b>3.8mm</b> (yellow box label & vial cap)	<b>3.0mm</b> (gray internal hex & cover cap)
<b>4.6mm</b> (green box label & vial cap)	<b>3.5mm</b> (yellow internal hex & cover cap)
<b>5.8mm</b> (blue box label & vial cap)	<b>4.5mm</b> (green internal hex & cover cap)

## References

1. Please see BioHorizons document #ML0130 for a complete review of BioHorizons implant research and each study's reported success rate.
2. Density of Bone: Effect on Surgical Approach and Healing. CE Misch. *Contemporary Implant Dentistry, Second Edition*. Mosby: St. Louis, 1999. 371-384.
3. The influence of 0.12 percent chlorhexidine digluconate rinses on the incidence of infectious complications and implant success. Lambert PM, Morris HF, Ochi S. *J Oral Maxillofac Surg* 1997;55(12 supplement 5):25-30.
4. Heat production by 3 implant drill systems after repeated drilling and sterilization. Chacon GE, Bower DL, Larsen PE, McGlumphy EA, Beck FM. *J Oral Maxillofac Surg*. 2006 Feb;64(2):265-9.
5. Root Form Surgery in the Edentulous Mandible: Stage I Implant Insertion. CE Misch. *Contemporary Implant Dentistry Second Edition*. Mosby: St. Louis, 1999. 347-369.

# ORDERING & WARRANTY INFORMATION

**Product Support Specialist:** \_\_\_\_\_

**Cell phone:** \_\_\_\_\_

**Fax:** \_\_\_\_\_

**BioHorizons Lifetime Warranty on Implants and Prosthetics:** All BioHorizons implants and prosthetic components include a Lifetime Warranty. BioHorizons implant or prosthetic components will be replaced if removal of that product is due to failure (excluding normal wear to overdenture attachments).

**Additional Warranties:** BioHorizons warranties instruments, surgical drills, taps, torque wrenches and Virtual Implant Placement (VIP) treatment planning software.

**(1) Surgical Drills and Taps:** Surgical drills and taps include a warranty period of ninety (90) days from the date of initial invoice. Surgical instruments should be replaced when they become worn, dull, corroded or in any way compromised. Surgical drills should be replaced after 12 to 20 osteotomies.<sup>4</sup>

**(2) Instruments:** The BioHorizons manufactured instrument warranty extends for a period of one (1) year from the date of initial invoice. Instruments include drivers, sinus lift components, implant site dilators and BioHorizons tools used in the placement or restoration of BioHorizons implants.

**(3) VIP treatment planning software:** VIP treatment planning software warranty extends for a period of ninety (90) days from the date of initial invoice. The warranty requires that VIP be used according to the minimum system requirements.

**(4) Compu-Guide surgical templates:** Compu-Guide surgical templates are distributed without making any modifications to the submitted Compu-Guide Prescription Form and VIP treatment plan ("as is"). BioHorizons does not make any warranties expressed or implied as it relates to surgical templates.

**Return Policy:** Product returns require a Return Authorization Form, which can be acquired by contacting Customer Care. The completed Return Authorization Form should be included with the returned product. For more information, please see the reverse side of the invoice that was shipped with the product.

**Disclaimer of Liability:** BioHorizons products may only be used in conjunction with the associated original components and instruments according to the Instructions for Use (IFU). Use of any non-BioHorizons products in conjunction with BioHorizons products will void any warranty or any other obligation, expressed or implied.

Treatment planning and clinical application of BioHorizons products are the responsibility of each individual clinician. BioHorizons strongly recommends completion of postgraduate dental implant education and adherence to the IFU that accompany each product. BioHorizons is not responsible for incidental or consequential damages or liability relating to use of our products alone or in combination with other products other than replacement or repair under our warranties.

Compu-Guide surgical templates are ordered under the control of a Clinician. The Clinician recognizes responsibility for use. Therefore, regardless of the real or proven damages, the liability to BioHorizons is limited to the price of the product directly related to the reason for the claim.

**Distributed Products:** For information on the manufacturer's warranty of distributed products, please refer to their product packaging. Distributed products are subject to price change without notice.

**Validity:** Upon its release, this literature supersedes all previously published versions.

**Availability:** Not all products shown or described in this literature are available in all countries. BioHorizons continually strives to improve its products and therefore reserves the right to improve, modify, change specifications or discontinue products at any time.

Any images depicted in this literature are not to scale, nor are all products depicted.

## Direct Offices

**BioHorizons USA**  
888-246-8338 or  
205-967-7880

**BioHorizons Canada**  
866-468-8338

**BioHorizons Spain**  
+34 91 713 10 84

**BioHorizons UK**  
+44 (0)1344 752560

**BioHorizons Germany**  
+49 761-556328-0

**BioHorizons Australia**  
+61 2 8399 1520

**BioHorizons Chile**  
+56 2 361 9519

## Distributors

For contact information in our 85 markets, visit [www.biohorizons.com](http://www.biohorizons.com)

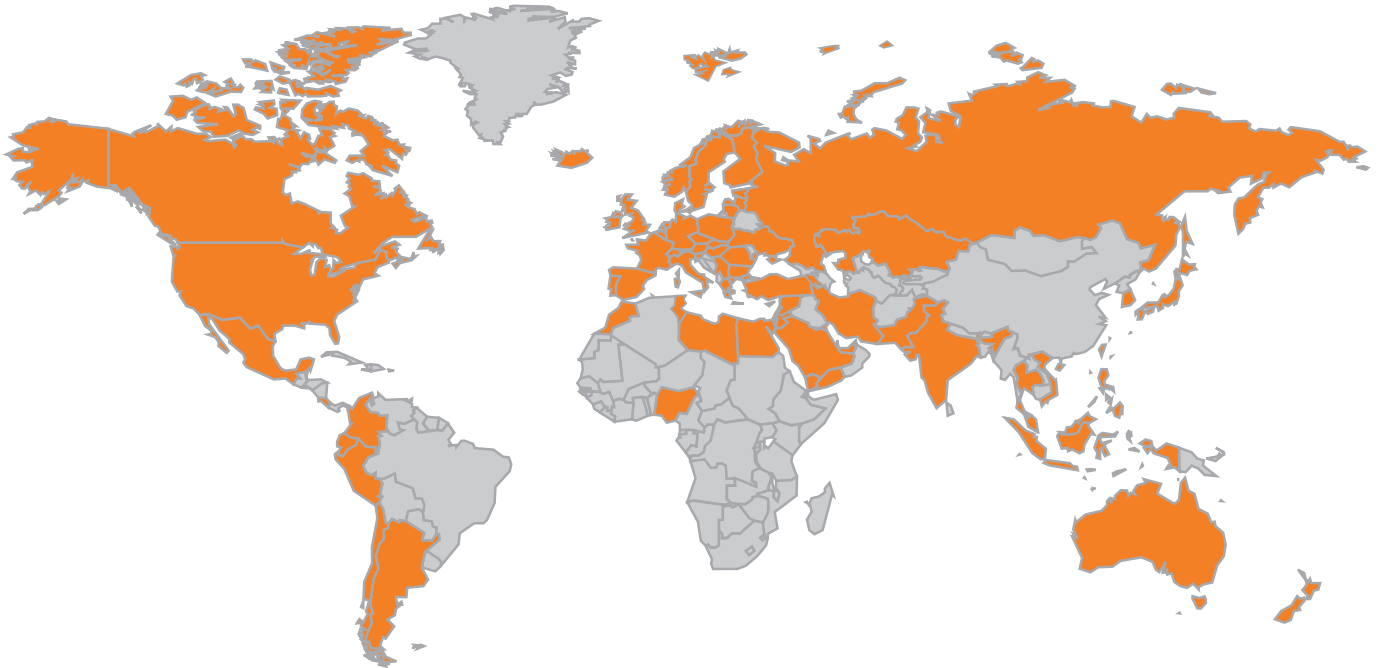

BioHorizons®, Laser-Lok®, MinerOss®, AutoTac® and Mem-Lok® are registered trademarks of BioHorizons IPH, Inc. Unigrip™ is a registered trademark of Nobel Biocare AB. Zimmer® Dental ScrewVent® and Tapered ScrewVent® are registered trademarks of Zimmer, Inc. AlloDerm® and AlloDerm GBR® are registered trademarks of LifeCell™ Corporation. The ARTISAN™ Space Maintenance System, Grafton® DBM and LADDEC® are registered trademarks of Medtronic, Inc. INFUSE® Bone Graft, the PROGENIX® Family of Grafts, and the MASTERGRAFT® Family of Products are registered trademarks of Medtronic Sofamor Danek Inc. Spiralock® is a registered trademark of Spiralock Corporation. Pomalux® is a registered trademark of Westlake Plastics Co. Locator is a registered trademark of Zest Anchors, Inc. Delrin® is a registered trademark of E.I. du Pont de Nemours and Company. MinerOss® Cancellous is processed by DCI Donor Services Tissue Bank. Mem-Lok® is manufactured by Collagen Matrix, Inc.

Not all products shown or described in this literature are available in all countries. As applicable, BioHorizons products are cleared for sale in the European Union under the EU Medical Device Directive 93/42/EEC and the tissues and cells Directive 2004/23/EC. We are proud to be registered to ISO 13485:2003, the international quality management system standard for medical devices, which supports and maintains our product licences with Health Canada and in other markets around the globe. Original language is English.

©BioHorizons IPH, Inc. All Rights Reserved.

shop online at  
**www.biohorizons.com**



L01024

REV B OCT 2012